

# Data Sheet



Article number: 339702380000

Description: Multibeam 6 Coupling 702.38.0000  
St. steel & set screw hubs

## Measures

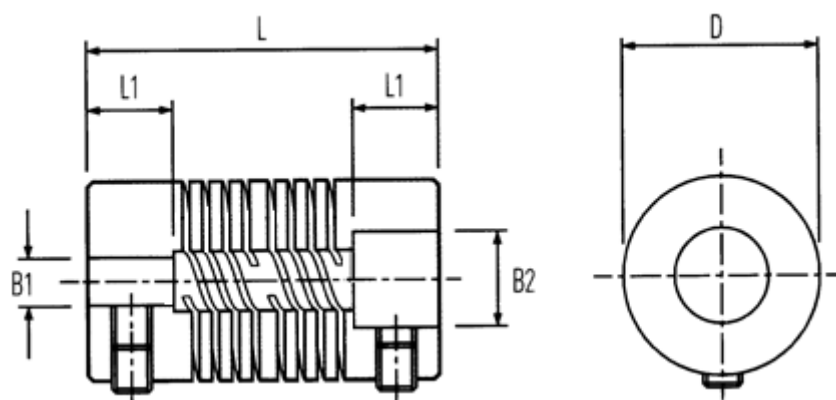

B1: Pre-drilled	= 8.0
B2: Pre-drilled	= 12.00
D	= 38.1
L	= 66.7
L1	= 18.0
Max angular displacement	= 0.60
Max B1 & B2	= 22.00
Max parallel displacement	= 7

Peak Torque NM	= 36.00
Set Screw	= M6